

Article number: 0101044
 Description: Retaining ring A 27 DIN 471
 Spring steel
 Note: Fitted with ZGA pilers

Measures

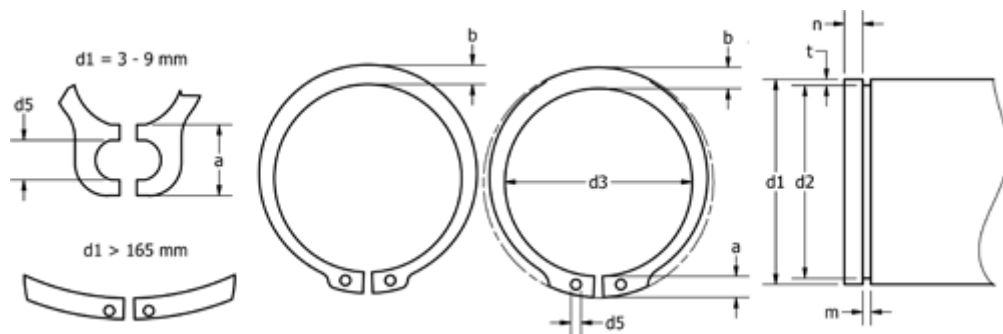

a max	= 4.6	FN kN	= 9.6	s	= 1.20
AN mm ²	= 57.8	FRg kN	= 3.80	t	= 0.70
b	= 3.1	FR kN	= 16.40	tol	= -0.21
d1	= 27	g	= 1.5	tol	= -0.06
d2	= 25.6	K kN-mm	= 33.40	tol	= +0,21-0,42
d3	= 24.9	m min	= 1.30	Tong	= ZGA-2
d5 min	= 2.0	n abl x 1000	= 22.0	Weight kg/1000	= 2.080
Description	= A27	Nominal drive	= 2.1		